

# *Grizzly* *Industrial, Inc.*®

## MODEL H7947/H7948 INSTRUCTION MANUAL

**H7947  $\frac{7}{16}$ "  
16 GAUGE STAPLER**



**H7948  $\frac{1}{2}$ "  
16 GAUGE STAPLER**

COPYRIGHT © DECEMBER, 2006 BY GRIZZLY INDUSTRIAL, INC.

WARNING: NO PORTION OF THIS MANUAL MAY BE REPRODUCED IN ANY SHAPE OR FORM WITHOUT THE WRITTEN APPROVAL OF GRIZZLY INDUSTRIAL, INC.

#JC8622 PRINTED IN TAIWAN

# SAFETY

## **WARNING**

### **For Your Own Safety Read Instruction Manual Before Operating This Equipment**

The purpose of safety symbols is to attract your attention to possible hazardous conditions. This manual uses a series of symbols and signal words which are intended to convey the level of importance of the safety messages. The progression of symbols is described below. Remember that safety messages by themselves do not eliminate danger and are not a substitute for proper accident prevention measures.

#### **DANGER**

Indicates an imminently hazardous situation which, if not avoided, WILL result in death or serious injury.

#### **WARNING**

Indicates a potentially hazardous situation which, if not avoided, COULD result in death or serious injury.

#### **CAUTION**

Indicates a potentially hazardous situation which, if not avoided, MAY result in minor or moderate injury. It may also be used to alert against unsafe practices.

#### **NOTICE**

This symbol is used to alert the user to useful information about proper operation of the equipment.

## **WARNING**

### **Safety Instructions For Pneumatic Tools**

- KEEP ALL SAFETY DEVICES IN PLACE** and in working order.
- REMOVE ADJUSTING KEYS AND WRENCHES.** Form habit of checking to see that keys and adjusting wrenches are removed from tool before operation.
- KEEP WORK AREA CLEAN.** Cluttered areas and benches invite accidents.
- DO NOT USE IN DANGEROUS ENVIRONMENT.** Do not use pneumatic tools in damp or wet locations, or where any flammable or noxious fumes may exist. Keep work area well lighted.
- KEEP CHILDREN AND VISITORS AWAY.** All children and visitors should be kept at a safe distance from work area.
- MAKE WORKSHOP CHILD PROOF** by locking your shop and shutting off air valves.
- DO NOT FORCE TOOL.** It will do the job better and safer at the rate for which it was designed.
- USE THE RIGHT TOOL.** Do not force tool or attachment to do a job for which it was not designed.
- DO NOT USE UNDER THE INFLUENCE OF DRUGS OR ALCOHOL.**

# WARNING

## Safety Instructions For Pneumatic Tools

10. **USE PROPER AIR HOSE** for the tool. Make sure your air hose is in good condition and is long enough to reach your work without stretching.
11. **WEAR PROPER APPAREL.** Do not wear loose clothing, gloves, neckties, rings, bracelets, or other jewelry which may get caught in moving parts. Non-slip footwear is recommended. Wear a protective hair covering to contain long hair.
12. **ALWAYS USE ANSI APPROVED SAFETY GLASSES.** Also use a face or dust mask if cutting operation is dusty. Everyday eyeglasses only have impact resistant lenses, they are NOT safety glasses.
13. **ALWAYS WEAR ANSI APPROVED HEARING PROTECTION.**
14. **SECURE WORK.** Use clamps or a vise to hold work when practical. It is safer than using your hand and frees both hands to operate tool.
15. **MAINTAIN TOOLS WITH CARE.** Keep tools lubricated and clean for best and safest performance. Follow instructions for lubricating and changing accessories.
16. **REDUCE THE RISK OF UNINTENTIONAL STARTING.** Do not carry tool with hand on trigger and always disconnect from air when not in use.
17. **DISCONNECT TOOLS** before servicing, changing accessories, or moving to another location.
18. **DO NOT OVERREACH.** Keep proper footing and balance at all times.
19. **USE THE RECOMMENDED ACCESSORIES.** Consult owner's manual for recommended accessories. The use of improper accessories may cause risk of injury.
20. **CHECK FOR DAMAGED PARTS BEFORE USING.** Check for binding and alignment of parts, broken parts, part mounting, loose bolts, and any other conditions that may affect machine operation. Repair or replace damaged parts.
21. **NEVER LEAVE UNATTENDED TOOL CONNECTED TO AIR.** Disconnect the air hose and do not leave tool until it is relieved of any built up pressure.
22. **NEVER ALLOW UNTRAINED USERS TO USE THIS TOOL WHILE UNSUPERVISED.**
23. **IF YOU ARE UNSURE OF THE INTENDED OPERATION, STOP USING THE TOOL.** Seek formal training or research books or magazines that specialize in pneumatic tools.

# WARNING

## Additional Safety Instructions for Staplers

- 1. HAND INJURIES:** Do not place your hands near the staple point of entry. A staple can deflect and tear through the surface of the workpiece, puncturing your hand or fingers.
- 2. COMBUSTIBLE GASES:** Never connect the stapler to pressurized oxygen or other combustible gases as a power source. Only use filtered, lubricated, and regulated compressed air.
- 3. SAFE HANDLING:** Never point the stapler at others! Do not keep the trigger pulled when loading fasteners, carrying, or holding tool. Carry the stapler only by the handle, never by any other part. Do not carry the stapler by the air hose. Disconnect the stapler from the air hose when going up and down ladders.
- 4. AIR HOSE:** Make sure your air hose is designed for the tool in use, is in good condition, and is long enough to reach your work without stretching. However, an overly long air hose in the work area may be a tripping hazard.
- 5. COMPRESSED AIR RATING:** Do not connect the stapler to compressed air that exceeds 120 PSI.
- 6. CHECK VALVE:** Do not use a check valve or any other fitting that allows air to remain in the tool.
- 7. CLEANING:** Never use gasoline or other flammable liquids to clean the stapler; vapors in the stapler may ignite by a spark and cause the stapler to explode.
- 8. OPERATING QUESTIONS:** If you are not sure about the intended operation, stop using the stapler. Seek formal training or research sources that specialize in pneumatic tools.
- 9. MAINTENANCE:** Always disconnect air from the stapler when servicing or installing staples. During adjustments or maintenance, a stapler connected to air may fire accidentally, causing serious personal injury.

## **!WARNING**

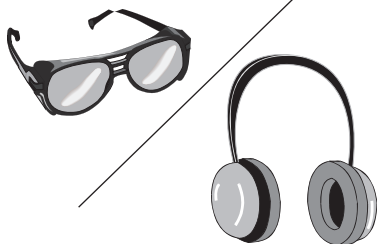

Operating this stapler can propel objects into the air, causing immediate eye damage. To protect yourself, always wear American National Standards Institute (ANSI) approved safety glasses or goggles when operating this equipment. In addition, the intensity of sound made by this stapler at discharge can reach 90 decibels. To protect your hearing, always wear ANSI approved ear protection when operating this stapler.

## **!WARNING**

Never point this stapler at yourself or another person! Always pay attention to the direction this stapler is pointed. Use this tool with respect and caution to lessen the possibility of operator or bystander injury. Ignoring this warning may result in serious personal injury.

## **!CAUTION**

Stapler accidents routinely happen while moving the gun to another location, such as up ladders, to another room, or even another job site. Always disconnect the gun immediately after use and never transport the gun while connected to the air—even if the air compressor is disconnected from its power source!

## **!WARNING**

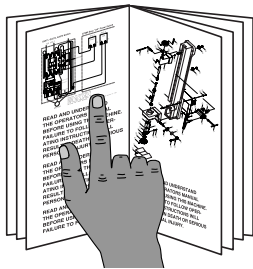

Read the manual before operation. Become familiar with these staplers, their safety instructions, and operation before beginning any work. Serious personal injury may result if safety or operational information is not understood or followed.

## **!CAUTION**

No list of safety guidelines can be complete. Every shop environment is different. Always consider safety first, as it applies to your individual working conditions. Use this and other tools with caution and respect. Failure to do so could result in serious personal injury, damage to equipment or poor work results.

# INTRODUCTION

---

---

## Foreword

---

---

We are proud to offer the Grizzly Model H7947/H7948 16 Gauge Stapler. This stapler is part of a growing Grizzly family of fine pneumatic tools. When used according to the guidelines in this manual, you can expect years of trouble-free, enjoyable operation and proof of Grizzly's commitment to customer satisfaction.

The specifications and photographs in this manual represent Model H7947/H7948 as supplied when this manual was prepared. However, owing to Grizzly's policy of continuous improvement, changes may be made at any time with no obligation on the part of Grizzly.

## Model H7947 Specifications

---

---

Staple Type ..... 16 Gauge Crown Wire  
Staple Crown Dimension .....  $\frac{7}{16}$ "  
Staple Length ..... 1"-2"  
Magazine Capacity ..... 150 Staples  
Weight ..... 4.65 lbs.  
Air Inlet .....  $\frac{1}{4}$ " NPT.  
Operating Pressure ..... 70-110 PSI

## Model H7948 Specifications

---

---

Staple Type ..... 16 Gauge Crown Wire  
Staple Crown Dimension .....  $\frac{1}{2}$ "  
Staple Length ..... 1"-2"  
Magazine Capacity ..... 150 Staples  
Weight ..... 4.65 lbs.  
Air Inlet .....  $\frac{1}{4}$ " NPT.  
Operating Pressure ..... 70-110 PSI

## Contact Info

---

---

If you have any comments regarding this manual, please write to us at the following address:

Grizzly Industrial, Inc.  
C/O Technical Documentation Manager  
P.O. Box 2069  
Bellingham, WA 98227-2069  
Email: manuals@grizzly.com

Most importantly, we stand behind our tools. If you have any service questions or parts requests, please call or write us at the location listed below.

Grizzly Industrial, Inc.  
1203 Lycoming Mall Circle  
Muncy, PA 17756  
Phone: (570) 546-9663  
Fax: (800) 438-5901  
E-Mail: techsupport@grizzly.com  
Web Site: <http://www.grizzly.com>

# SETUP

## Unpacking

Your Model H7947/H7948 left our warehouse in a carefully packed box. If you discover the stapler is damaged after you have signed for delivery, *please immediately call Customer Service at (570) 546-9663 for advice.*

Save the containers and all packing materials for possible inspection by the carrier or its agent. *Otherwise, filing a freight claim can be difficult.*

When you are completely satisfied with the condition of the shipment, you should inventory the equipment.

## Inventory

After you open the stapler box, you should find the following.

### Model H7947/H7948 (Figure 1)

- A. Stapler..... 1
- B. Stapler Case ..... 1
- C. Pneumatic Tool Oil ..... 1
- D. Hex Wrench 4mm ..... 1
- E. O-Rings..... 2



Figure 1. Model H7947/H7948 inventory.

# Compressed Air System

The Model H7947/H7948 is designed to be operated at 70–110 PSI using clean, dry, regulated, compressed air. DO NOT exceed 120 PSI.

An in-line filter/lubricator/regulator unit, depicted in **Figure 2**, can be installed and should be located as close to the stapler as possible.

This filter/lubricator/regulator unit will protect your tool from damaging water build-up, allow you to adjust and maintain constant air pressure to your tool, and save you the inconvenience of manually lubricating your tool every time you use it.

Check the current Grizzly catalog for availability of this unit. If you plan on installing a filter/lubricator/regulator unit in your compressed air system, always follow the connection instructions that come with the unit.

## **⚠️ WARNING**

**Exceeding the maximum permissible operating pressure may damage the seals, gaskets and hammer mechanism of your stapler. DO NOT allow your air compressor to exceed the recommended pressure when connected to this stapler or serious personal injury may result!**

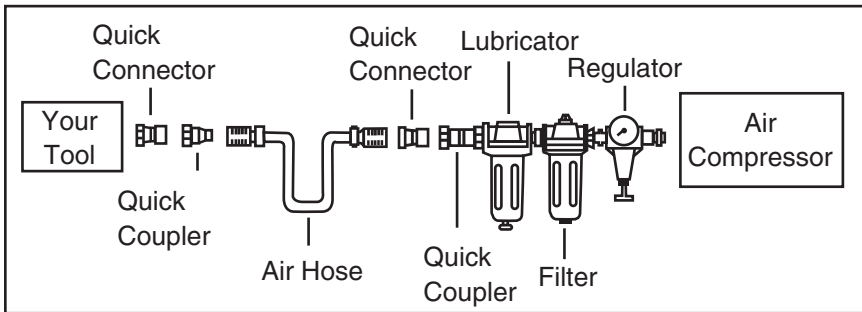

**Figure 2.** Typical filter/lubricator/regulator installation order.



# Testing Safety Nose Mechanism

---

---

A safety mechanism (bump fire) on the nose of the stapler protects against accidental firing. This mechanism is activated when staples are loaded into the magazine. The stapler will not fire when the trigger is pulled until the safety nose is fully depressed.

Before you use your stapler for the first time, check the safety nose mechanism to ensure proper function.

## **WARNING**

**The safety mechanism is a mechanical device that can fail. Never rely on this mechanism as an excuse to point the stapler at yourself or any bystanders, otherwise, serious injury may occur.**

**To verify that the safety nose is working correctly:**

1. **DISCONNECT STAPLER FROM THE AIR SUPPLY!**
2. Insert a strip of staples in the magazine (see **Page 8** for instructions).
3. Make sure the trigger and the safety nose mechanism move up and down without sticking.
4. Connect the stapler to the air supply.

## **WARNING**

**Point the stapler away from you and others when connecting the air supply. The stapler can cycle and discharge a staple when the air supply is connected. Ignoring this warning may result in serious personal injury.**

5. Without pressing the trigger, depress the safety nose mechanism against a scrap piece of wood that is clean and free of any knots, staples, or other foreign objects.

— If the stapler does not fire, then the safety nose mechanism is working correctly.

— If the stapler does fire when you depress the safety nose, immediately disconnect the stapler from the air supply and call Grizzly Technical Support at (570) 546-9663 for help.

6. Without depressing the safety nose, point the stapler in a safe direction, and pull the trigger.

— If the stapler does not fire, then the safety nose mechanism is working correctly.

— If the stapler does fire when the trigger is pulled, without the safety nose mechanism being depressed, immediately disconnect the stapler from the air supply and call Grizzly Technical Support at (570) 546-9663 for help.

# OPERATIONS

---

---

## Loading Staples

---

---

Use staples meeting the specifications listed for your stapler on **Page 4** of this manual.

To load staples in your stapler:

1. DISCONNECT STAPLER FROM THE AIR SUPPLY!

### WARNING

Point the stapler away from you and others when connecting the air supply. The stapler can cycle and discharge a staple when the air supply is connected. Ignoring this warning may result in serious personal injury.

2. Slide the magazine pusher to the rear of the magazine and pivot the pusher down until it catches in the lock notch on the magazine as shown in **Figure 3**.

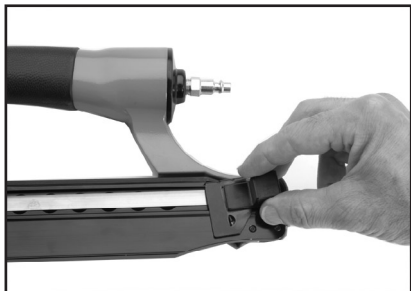

**Figure 3.** Locking the pusher.

3. With the pusher locked at the rear of the magazine, insert a strip of staples into the magazine as shown in **Figure 4**.
- 4.

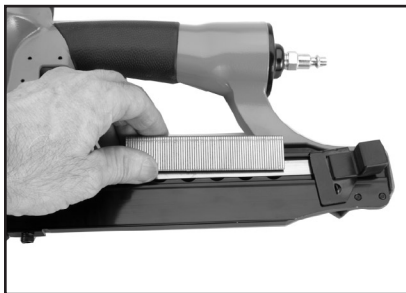

**Figure 4.** Loading a staple strip into the magazine.

4. Lift the pusher out of the lock notch and guide it forward to push the staple strip to the nose of the stapler.

## Unloading Staples

---

---

To remove unused staples:

1. DISCONNECT STAPLER FROM THE AIR SUPPLY!
2. Point the stapler away from you and all bystanders.
3. Slide the pusher to the rear of the magazine and latch it into the lock notch.
4. Move the staples back from the nose and lift them up and out of the magazine.

## Rotating Exhaust Cover

The exhaust cover rotates as needed to direct the exhaust away from you.

### To rotate the exhaust cover:

1. Use the 4mm hex wrench to loosen the exhaust cover cap screw as shown in **Figure 5**.

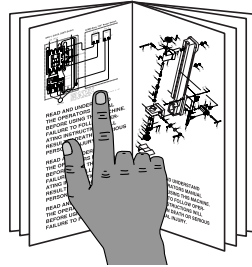

**Figure 5.** Loosening the exhaust cap screw.

2. Rotate the exhaust cover by hand to aim the exhaust port in the desired direction.
3. Tighten the exhaust cover cap screw.

## Using the Stapler

### **⚠️ WARNING**



**Read the manual before operation. Become familiar with these staplers, their safety instructions, and operation before beginning any work. Serious personal injury may result if safety or operational information is not understood or followed.**

Before you operate your stapler, place five to six drops of air tool oil into the quick connect fitting where the stapler connects to the air supply.

### To operate your stapler:

1. Connect the air supply to the quick connect fitting on your stapler.
2. To test for proper staple penetration, hold the stapler perpendicular to the surface of a piece of clean scrap wood that is thick enough for the length of staples you have loaded.
3. Depress the safety nose mechanism against your workpiece.

- Before pulling the trigger, make sure your free hand and other body parts are positioned out of the way of a potential path of a staple in case of deflection (illustrated below in **Figure 6**).

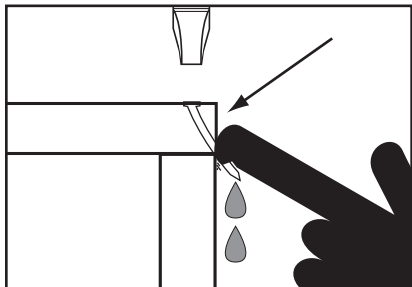

**Figure 6.** Example of staple deflection.

**Note:** Deflection is caused when grain irregularities, knots or foreign objects inside the wood cause the staple to change its path, resulting in the staple puncturing the surface of the workpiece.

Besides damaging your workpiece, deflection can cause injury if your free hand is securing the workpiece in the location that the staple deflects.

- Pull the trigger.
  - If the staple penetrates the wood to the depth you want, continue with your intended operations.
  - If the staple either went too far or not far enough, adjust the depth of fire by following the procedures listed on **Pages 10-11**.

## Adjusting Depth

Changing the depth of staple penetration is done by changing the position of the adjusting block on the contact arm.

### To adjust the depth:

- DISCONNECT STAPLER FROM THE AIR SUPPLY.
- Use a 4mm hex wrench to loosen the depth adjustment cap screw on the contact arm as shown in **Figure 7**.

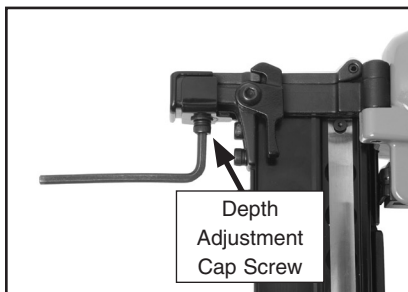

**Figure 7.** Depth adjustment cap screw.

- Move the adjusting block (**Figure 8**) up or down to increase or decrease staple penetration.
  - If you want to decrease the staple depth, then move the adjusting block down, away from the nose as shown in **Figure 8**.

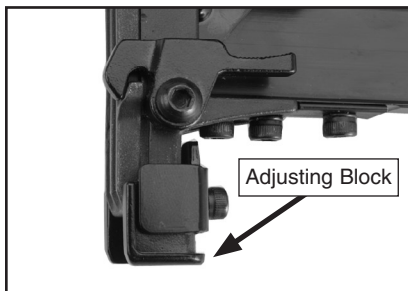

**Figure 8.** Adjusting block down.

- If you want to increase the staple depth, then move the adjusting block up, toward the nose as shown in **Figure 9**.

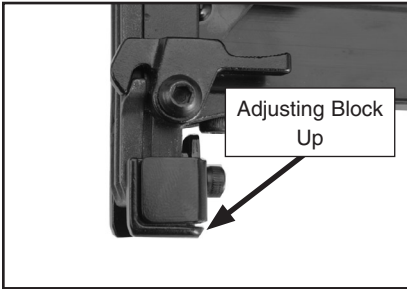

**Figure 9.** Moving the adjustment block up.

4. Tighten the depth adjustment cap screw.
5. Connect the stapler to the air supply, test the staple depth, and repeat this entire procedure if necessary until the staple depth is satisfactory.

## Clearing Jammed Staples

A jammed staple must be cleared before the stapler is used again.

**To clear a jammed staple from the discharge area:**

1. **DISCONNECT STAPLER FROM THE AIR SUPPLY!**

2. Unlatch the nose cover as shown in **Figure 10**.



**Figure 10.** Unlatching the nose cover.

3. Open the nose cover as shown in **Figure 11**.



**Figure 11.** Opening the nose cover.

4. Grab the jammed staple with a pair of pliers and remove it from the nose as shown in **Figure 12**.



**Figure 12.** Removing a jammed staple.

5. Close and latch the nose cover.

# Replacing Pistons/O-Rings

If you need to replace piston parts in your stapler, you can purchase a piston repair kit from Grizzly: call 1-800-523-4777.

The Piston Repair Kit part number for Model H7947 is PH7947081; the Piston Repair Kit part number for Model H7948 is PH7948081.

Refer to the parts breakdown during this procedure to identify parts and their locations inside the stapler.



## To replace a piston and O-ring(s):

1. DISCONNECT STAPLER FROM THE AIR SUPPLY!
2. Remove all staples from the magazine.
3. Remove the four screws that secure the stapler cap and remove the cylinder cap.

4. Push the top of the piston down with your finger as far as it will go; this will push the piston driver into the nose of the stapler.
5. Open the nose cover of the stapler to reveal the piston driver.
6. Use a narrow, flathead screwdriver to push the piston driver up until the piston head clears the top of the cylinder. (Be careful not to scratch the discharge area, the driver set plate or the piston cylinder.)
7. Grip the piston head by hand and remove the piston assembly from the cylinder.
8. Clean all metal parts with an automotive grade solvent. Clear all ports and blow the solvent away with compressed air.
9. Replace any part that shows damage or heavy wear. Relubricate the tool.
10. Apply a thin film of the stapler lubricating oil on the new O-ring and place it on the new piston. Install any other parts included in the piston repair kit.
11. Insert the new piston in the cylinder. With the magazine cover open, gently push the piston down to make sure the piston driver moves freely into the driving hole.

**Note:** *DO NOT force the piston into the cylinder! If the piston 'hangs' in the cylinder, double check the fit between piston and O-ring and make sure the cylinder is clean.*

12. Make sure that the cap gasket is in place, then secure the cap to the stapler body by tightening the four cap screws.

# CLEANING & LUBRICATING

## Cleaning

Use an automotive grade solvent such as Sprayway C-60® (G2544 in the Grizzly catalog) to clean the nose assembly of the stapler. Always be sure that the stapler is dry before using it again.

Do not allow dust, chips, or sand into the air connectors or into the body of the stapler; this may result in leaks and damage to the stapler and the air couplings.

### **WARNING**



**Never use gasoline to clean this tool. Use extreme caution when using any solvent cleaner. Always clean the tool in a well-ventilated area and never if sparks or open flames are present. Remember that electrical machinery in the area can produce sparks during normal operation. Ignoring this warning can cause serious personal injury or even death!**

## Lubricating

Special pneumatic tool oil has been included with your new Grizzly stapler to help maintain its useful life. Place two to six drops of oil in the stapler air inlet (as shown in **Figure 13**) every two hours of continuous use.

Wipe off any excess oil near the stapler exhaust to avoid dust build-up. When the oil that was included with your stapler has been completely used, replace with Grizzly Model G2820 Pneumatic Tool Oil.

An efficient alternative to oiling your tool by hand is to install a lubricator in your air compressor line. If your air compressor line already has a lubricator, then regular lubrication of your stapler will not be necessary. Just make sure there is always oil in the lubricator.

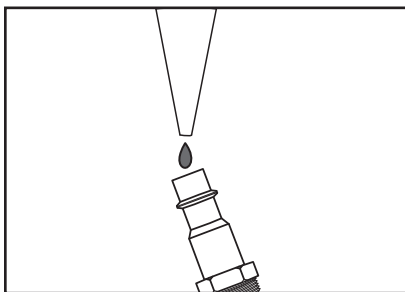

**Figure 13.** Lubricating the stapler at the air inlet.

# H7947 PARTS BREAKDOWN

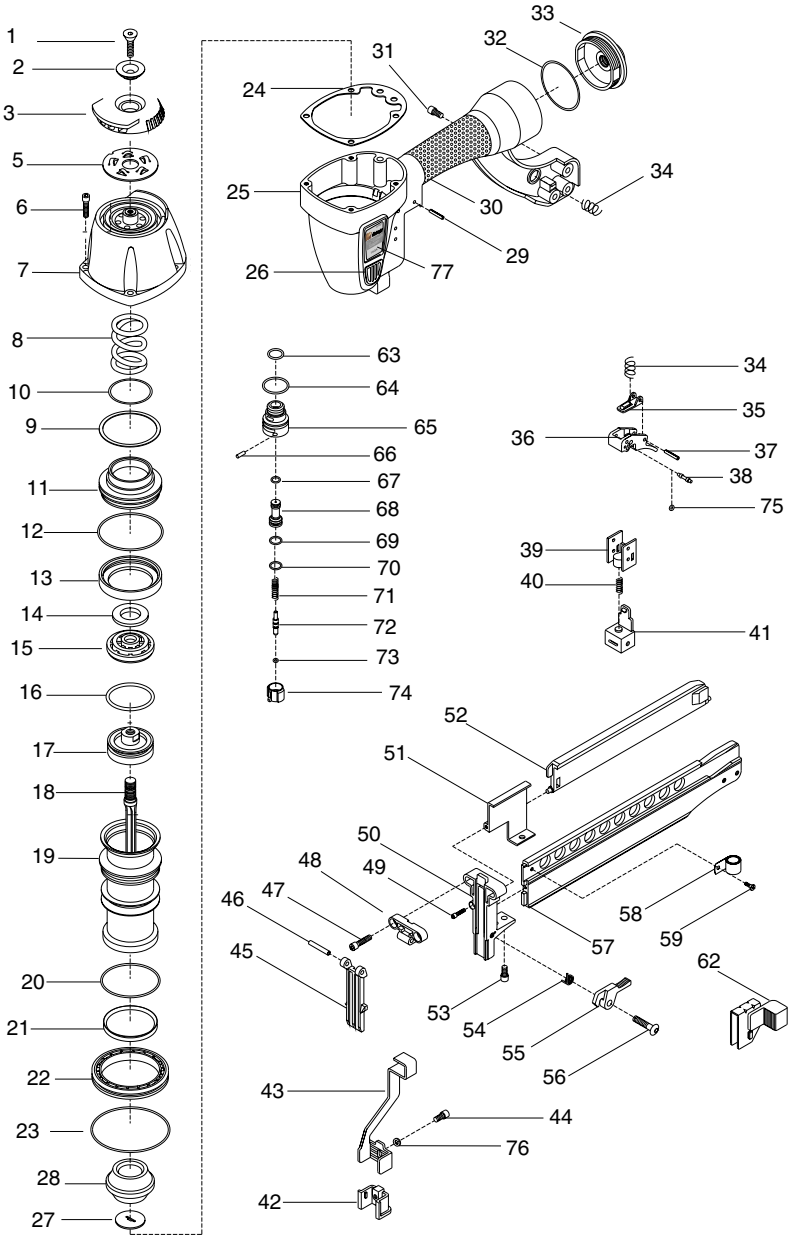

Not Shown: #78 Stapler Case, #79 Included Pneumatic Oil,  
 #80 Included Hex Wrench 4MM, #81 Piston Repair Kit.



# H7947 PARTS LIST

REF PART #	DESCRIPTION
1	PFH06M FLAT HD CAP SCR M6-1 X 20
2	PH7947002 FRONT BRACKET
3	PH7947003 EXHAUST COVER
5	PH7947005 EXHAUST FILTER PLATE
6	PSB38M CAP SCREW M5-.8 X 25
7	PH7947007 CAP
8	PH7947008 SPRING
9	PH7947009 O-RING
10	PH7947010 WASHER
11	PH7947011 PISTON HEAD VALVE
12	PH7947012 O-RING
13	PH7947013 SEAL
14	PH7947014 PLAIN WASHER
15	PH7947015 PISTON STOPPER
16	PH7947016 O-RING
17	PH7947017 PISTON
18	PH7947018 DRIVER
19	PH7947019 CYLINDER
20	PH7947020 O-RING
21	PH7947021 CYLINDER RING
22	PH7947022 COLLAR
23	PH7947023 O-RING
24	PH7947024 GASKET
25	PH7947025 BODY
26	PH7947026 PAD
27	PH7947027 SET PLATE
28	PH7947028 BOTTOM BUMPER
29	PRP97M ROLL PIN 3 X 30
30	PH7947030 RUBBER GRIP
31	PSB24M CAP SCREW M5-.8 X 16
32	PH7947032 O-RING
33	PH7947033 COVER
34	PH7947034 SPRING
35	PH7947035 TRIGGER PLATE
36	PH7947036 TRIGGER
37	PRP02M ROLL PIN 3 X 16
38	PH7947038 SLIDE SHAFT
39	PH7947039 TRIP GUIDE
40	PH7947040 SPRING

REF PART #	DESCRIPTION
41	PH7947041 CONTACT TRIP BLOCK
42	PH7947042 ADJUSTING BLOCK
43	PH7947043 CONTACT ARM
44	PSB33M CAP SCREW M5-.8 X 12
45	PH7947045 DRIVER GUIDE PLATE
46	PRP04M ROLL PIN 4 X 24
47	PSB79M CAP SCREW M5-.8 X 32
48	PH7947048 SET BLOCK
49	PH7947049 CAP SCREW M3-.6 X 16
50	PH7947050 NOSE
51	PH7947051 MAGAZINE COVER
52	PH7947052 STAPLE GUIDE
53	PSB33M CAP SCREW M5-.8 X 12
54	PH7947054 SPRING
55	PH7947055 STOPPER
56	PH7947056 BUTTON HD CAP SCR M5-.8 X 60
57	PH7947057 MAGAZINE
58	PH7947058 SPIRAL SPRING
59	PH7947059 FLAT HD SCR M3-.5 X 5
62	PH7947062 PUSHER GUIDE
63	PH7947063 O-RING
64	PH7947064 O-RING
65	PH7947065 TRIGGER VALVE HOUSING
66	PH7947066 BALL PIN
67	PH7947067 O-RING
68	PH7947068 PILOT VALVE
69	PH7947069 O-RING
70	PH7947070 O-RING
71	PH7947071 SPRING
72	PH7947072 PLUNGER
73	PH7947073 O-RING
74	PH7947074 TRIGGER VALVE CAP
75	PH7947075 O-RING
76	PW02M FLAT WASHER 5MM
77	PH7947077 MACHINE LABEL
78	PH7947078 STAPLER CASE
79	PH7947079 INCLUDED PNEUMATIC OIL
80	PAW04M INCLUDED HEX WRENCH 4MM
81	PH7947081 PISTON REPAIR KIT

# H7948 PARTS BREAKDOWN

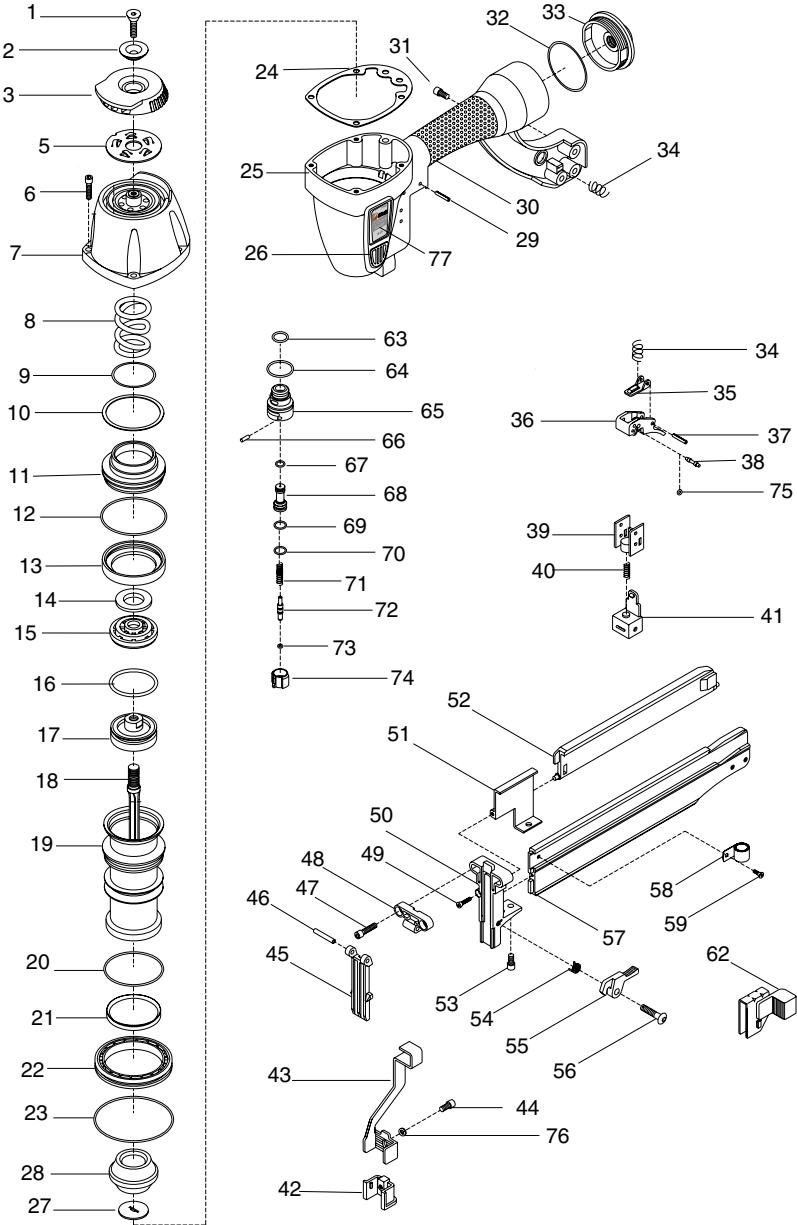

Not Shown: #78 Stapler Case, #79 Included Pneumatic Oil,  
 #80 Included Hex Wrench 4MM, #81 Piston Repair Kit.

# H7948 PARTS LIST

REF PART #	DESCRIPTION
1	PFH06M FLAT HD CAP SCR M6-1 X 20
2	PH7947002 FRONT BRACKET
3	PH7947003 EXHAUST COVER
5	PH7947005 EXHAUST FILTER PLATE
6	PSB38M CAP SCREW M5-.8 X 25
7	PH7947007 CAP
8	PH7947008 SPRING
9	PH7947009 O-RING
10	PH7947010 WASHER
11	PH7947011 PISTON HEAD VALVE
12	PH7947012 O-RING
13	PH7947013 SEAL
14	PH7947014 PLAIN WASHER
15	PH7947015 PISTON STOPPER
16	PH7947016 O-RING
17	PH7947017 PISTON
18	PH7948018 DRIVER
19	PH7947019 CYLINDER
20	PH7947020 O-RING
21	PH7947021 CYLINDER RING
22	PH7947022 COLLAR
23	PH7947023 O-RING
24	PH7947024 GASKET
25	PH7947025 BODY
26	PH7947026 PAD
27	PH7948027 SET PLATE
28	PH7947028 BOTTOM BUMPER
29	PRP97M ROLL PIN 3 X 30
30	PH7947030 RUBBER GRIP
31	PSB24M CAP SCREW M5-.8 X 16
32	PH7947032 O-RING
33	PH7947033 COVER
34	PH7947034 SPRING
35	PH7947035 TRIGGER PLATE
36	PH7947036 TRIGGER
37	PRP02M ROLL PIN 3 X 16
38	PH7947038 SLIDE SHAFT
39	PH7947039 TRIP GUIDE
40	PH7947040 SPRING

REF PART #	DESCRIPTION
41	PH7947041 CONTACT TRIP BLOCK
42	PH7947042 ADJUSTING BLOCK
43	PH7947043 CONTACT ARM
44	PSB33M CAP SCREW M5-.8 X 12
45	PH7947045 DRIVER GUIDE PLATE
46	PRP04M ROLL PIN 4 X 24
47	PSB79M CAP SCREW M5-.8 X 32
48	PH7947048 SET BLOCK
49	PH7947049 CAP SCREW M3-.6 X 16
50	PH7948050 NOSE
51	PH7947051 MAGAZINE COVER
52	PH7947052 STAPLE GUIDE
53	PSB33M CAP SCREW M5-.8 X 12
54	PH7947054 SPRING
55	PH7947055 STOPPER
56	PH7947056 BUTTON HD CAP SCR M5-.8 X 60
57	PH7948057 MAGAZINE
58	PH7947058 SPIRAL SPRING
59	PH7947059 FLAT HD SCR M3-.5 X 5
62	PH7948062 PUSHER GUIDE
63	PH7947063 O-RING
64	PH7947064 O-RING
65	PH7947065 TRIGGER VALVE HOUSING
66	PH7947066 BALL PIN
67	PH7947067 O-RING
68	PH7947068 PILOT VALVE
69	PH7947069 O-RING
70	PH7947070 O-RING
71	PH7947071 SPRING
72	PH7947072 PLUNGER
73	PH7947073 O-RING
74	PH7947074 TRIGGER VALVE CAP
75	PH7947075 O-RING
76	PW02M FLAT WASHER 5MM
77	PH7948077 MACHINE LABEL
78	PH7948078 STAPLER CASE
79	PH7947079 INCLUDED PNEUMATIC OIL
80	PAW04M HEX WRENCH 4MM
81	PH7948081 PISTON REPAIR KIT

# TROUBLESHOOTING

Symptom	Possible Cause	Solution
Air leaking at trigger valve area.	1. O-rings in trigger valve housing are damaged.	1. O-rings must be replaced.
Air leaking between housing and hose.	1. Loose screws in housing. 2. Damaged O-ring. 3. Loose air fitting.	1. Tighten screws. 2. Replace O-ring. 3. Tighten air fitting & use Teflon tape.
Air leaking between housing and cap assembly.	1. Damaged cap gasket.	1. Replace gasket.
Tool skips staples while discharging.	1. Air leaks. 2. Dirt in nose. 3. Dirt or damage prevents staples from moving freely in magazine.  4. Inadequate air flow to tool.  5. Worn O-ring on piston or lack of lubrication. 6. Damaged O-rings on trigger valve. 7. Worn bumper.	1. Tighten screws and fittings. 2. Clean nose. 3. Clean magazine, inspect/repair damage; insert a clean strip of staples.  4. Check fitting, hose, compressor & air pressure. 5. Replace piston O-ring. Lubricate. 6. Replace trigger valve O-rings. 7. Replace bumper.
Tool runs slowly or has a loss of power.	1. Stapler is not sufficiently lubricated. 2. Compressor is not supplying at least 70 PSI of air pressure to the tool. 3. Exhaust port in cap is blocked.	1. Lubricate stapler.  2. Repair or replace compressor.  3. Clean or replace damaged internal parts.
Staples frequently jam in the stapler nose.	1. Staples are the wrong size. 2. Staples are bent or dirty.  3. Magazine or nose screws are loose. 4. Driver or driver guide are worn or damaged.	1. Use correct staples. 2. Use undamaged, clean staples. 3. Tighten magazine.  4. Replace worn or damaged parts.
Stapler does not fire.	1. Staple is jammed in magazine or discharge area. 2. Piston shaft is damaged. 3. Air pressure too low.	1. Clear stapler magazine or discharge area. 2. Replace piston shaft. 3. Check/increase air pressure.

# WARRANTY AND RETURNS

---

Grizzly Industrial, Inc. warrants every product it sells for a period of **1 year** to the original purchaser from the date of purchase. This warranty does not apply to defects due directly or indirectly to misuse, abuse, negligence, accidents, repairs or alterations or lack of maintenance. This is Grizzly's sole written warranty and any and all warranties that may be implied by law, including any merchantability or fitness, for any particular purpose, are hereby limited to the duration of this written warranty. We do not warrant or represent that the merchandise complies with the provisions of any law or acts unless the manufacturer so warrants. In no event shall Grizzly's liability under this warranty exceed the purchase price paid for the product and any legal actions brought against Grizzly shall be tried in the State of Washington, County of Whatcom.

We shall in no event be liable for death, injuries to persons or property or for incidental, contingent, special, or consequential damages arising from the use of our products.

To take advantage of this warranty, contact us by mail or phone and give us all the details. We will then issue you a "Return Authorization Number," which must be clearly posted on the outside as well as the inside of the carton. We will not accept any item back without this number. Proof of purchase must accompany the merchandise.

The manufacturers reserve the right to change specifications at any time because they constantly strive to achieve better quality equipment. We make every effort to ensure that our products meet high quality and durability standards and we hope you never need to use this warranty.

Please feel free to write or call us if you have any questions about the machine or the manual.

**Grizzly Industrial, Inc.**  
**1203 Lycoming Mall Circle**  
**Muncy, PA 17756**  
**Phone: (570) 546-9663**  
**Fax: (800) 438-5901**

**E-Mail:**  
**techsupport@grizzly.com**

**Web Site: <http://www.grizzly.com>**

Thank you again for your business and continued support. We hope to serve you again soon!





# WARRANTY CARD

Name \_\_\_\_\_

Street \_\_\_\_\_

City \_\_\_\_\_ State \_\_\_\_\_ Zip \_\_\_\_\_

Phone # \_\_\_\_\_ Email \_\_\_\_\_ Invoice # \_\_\_\_\_

Model # \_\_\_\_\_ Order # \_\_\_\_\_ Serial # \_\_\_\_\_

*The following information is given on a voluntary basis. It will be used for marketing purposes to help us develop better products and services. **All information is strictly confidential.***

**1. How did you learn about us?**

Advertisement     Friend     Catalog  
 Card Deck     Website    Other: \_\_\_\_\_

**2. Which of the following magazines do you subscribe to?**

Cabinet Maker     Popular Mechanics     Today's Homeowner  
 Family Handyman     Popular Science     Wood  
 Hand Loader     Popular Woodworking     Wooden Boat  
 Handy     Practical Homeowner     Woodshop News  
 Home Shop Machinist     Precision Shooter     Woodsmith  
 Journal of Light Cont.     Projects in Metal     Woodwork  
 Live Steam     RC Modeler     Woodworker West  
 Model Airplane News     Rifle     Woodworker's Journal  
 Modeltec     Shop Notes     Other:  
 Old House Journal     Shotgun News

**3. What is your annual household income?**

\$20,000-\$29,000     \$30,000-\$39,000     \$40,000-\$49,000  
 \$50,000-\$59,000     \$60,000-\$69,000     \$70,000+

**4. What is your age group?**

20-29     30-39     40-49  
 50-59     60-69     70+

**5. How long have you been a woodworker/metalworker?**

0-2 Years     2-8 Years     8-20 Years     20+ Years

**6. How many of your machines or tools are Grizzly?**

0-2     3-5     6-9     10+

**7. Do you think your machine represents a good value?**     Yes     No

**8. Would you recommend Grizzly Industrial to a friend?**     Yes     No

**9. Would you allow us to use your name as a reference for our customers in your area?**

Note: *We never use names more than 3 times.*     Yes     No

**10. Comments:** \_\_\_\_\_

\_\_\_\_\_

\_\_\_\_\_

\_\_\_\_\_

Send a Grizzly Catalog to a friend:

Name _____
Street _____
City _____ State _____ Zip _____

FOLD ALONG DOTTED LINE

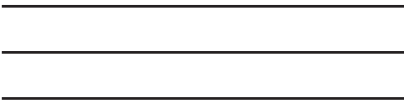

Place  
Stamp  
Here



GRIZZLY INDUSTRIAL, INC.  
P.O. BOX 2069  
BELLINGHAM, WA 98227-2069



TAPE ALONG EDGES--PLEASE DO NOT STAPLE